

- Single λ
- OOK Modulation
- Single Polarization
- Data Rate: 1X

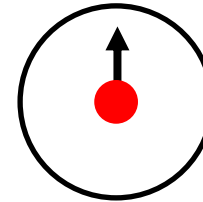

- Single λ
- PAM Modulation
- Single Polarization
- Data Rate: 2X

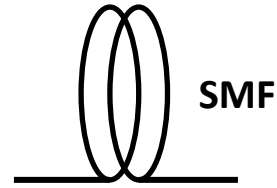
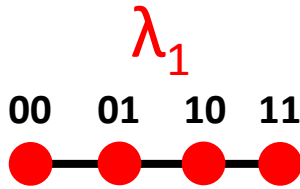
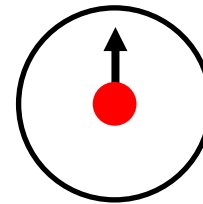
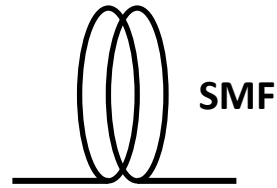
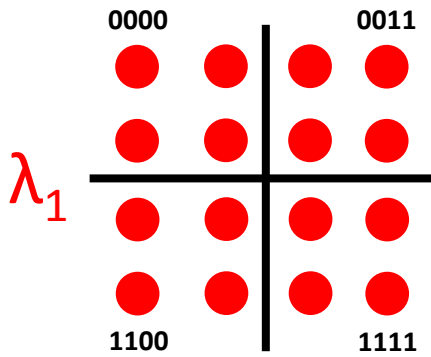

- Single λ
- QAM Modulation
- Single Polarization
- Data Rate: 4X

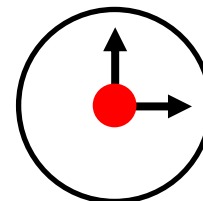
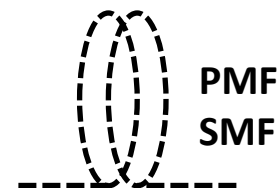
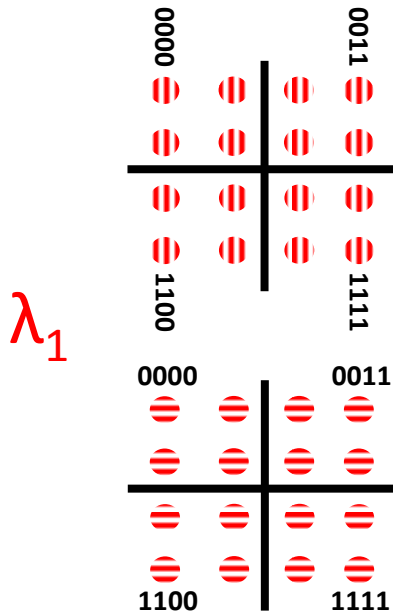

- Single λ
- QAM Modulation
- Dual Polarization (PDM)
- Data Rate: 8X

λ_2
 λ_1

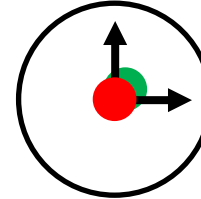
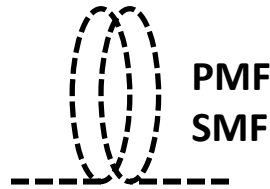
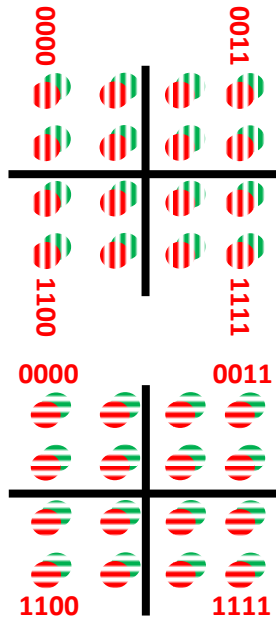

- Dual λ (WDM)
- QAM Modulation
- Dual Polarization (PDM)
- Data Rate: 16X

λ_2
 λ_1

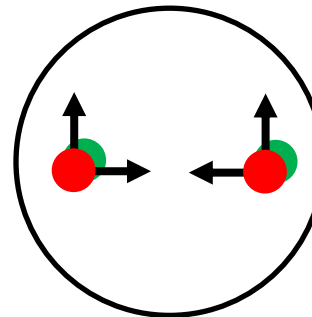
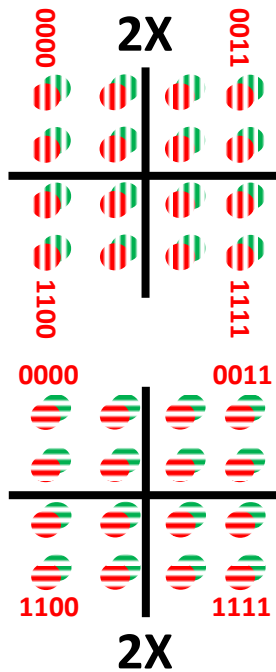

- Dual λ (WDM)
- QAM Modulation
- Dual Polarization (PDM)
- Multi-Core Fiber (SDM)
- Data Rate: 32X